













KMA Genuine Approved Accessories

| | | | |
|-----------------|-------------|----------------------|-------------|
| Vehicle Model | Soul | Accessory Difficulty | Cargo Liner |
| Model Year | 2010~ | | (A) |
| KMA Part No. | U8180 2K000 | | |
| Vendor Part No. | U8180 2K000 | | |

- Kit Overview
- Accessory Installation
- Visual Check
- Care & Cleaning

Note: Difficulty stated above reflects the minimum level of expertise required to install the accessory
 (A) Customer (B) Dealer Technician (C) Master Technician

Instructional Symbols / Definitions

| | | | | | |
|---|---|---|---|--|---|
|  | Denotes warnings that may lead to serious physical injury or vehicle damage. |  | Denotes quality processes to be checked prior to moving to the next step. | Denotes safety equipment required to be used such as a mask, goggles, rubber gloves, and hearing protection. | |
|  | Denotes cautions to be taken to avoid physical injury or electronic component damage. |  | Denotes specific tools that are necessary to complete the step. |  |  |
|  | Denotes cautions to be taken to avoid vehicle and component damage. |  | Denotes instructional steps necessary to complete the process. |  |  |
| | | | | Mask | Goggles |
| | | | | Rubber Gloves | Hearing Protection |

Basic Required Hand Tools

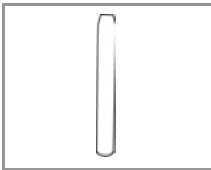

Trim Tool

Specialty Required Tools

None

Notes to the Installer

- Read the entire installation pamphlet prior to beginning the installation of the accessory.
- Ensure that the vehicle is properly protected in the area that the accessory is to be installed.
- To prevent vehicle damage, never place tools on top of painted surfaces, seats, dash pad, console or floor carpet / mat.
- Always wear appropriate safety gear to include gloves and eye protection when required.

KMA Genuine Approved Accessories (Kit Overview)

Kit Overview

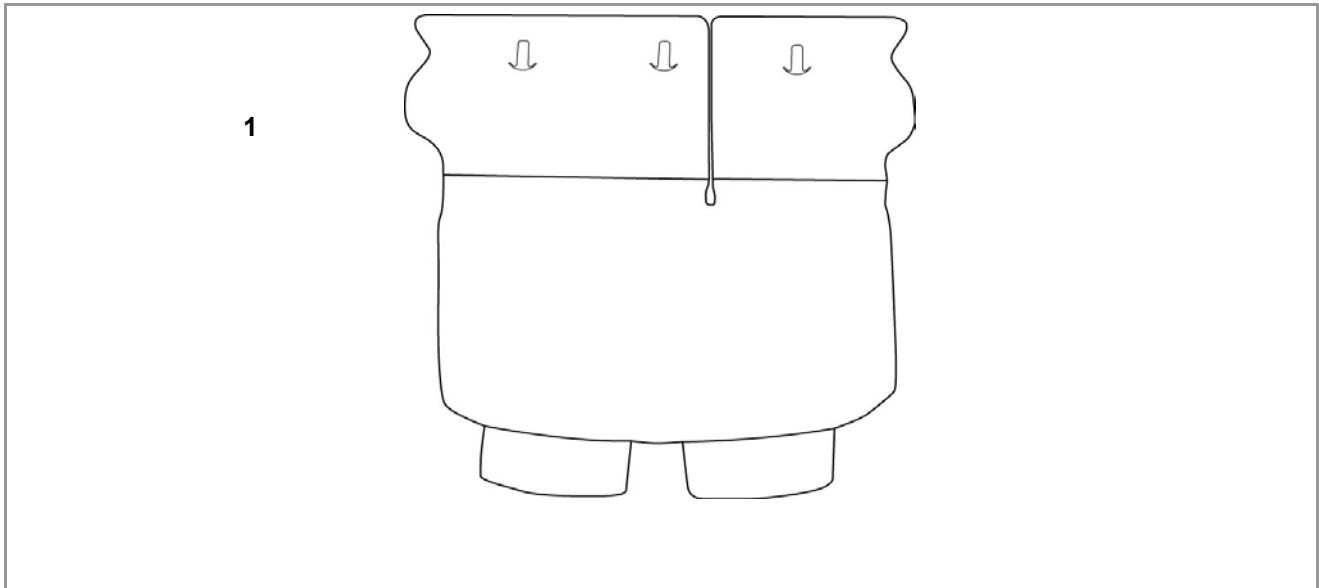

| No. | Qty. | Description |
|-----|------|-------------|
| 1 | 1 | Cargo Liner |

KMA Genuine Approved Accessories (Accessory Installation)

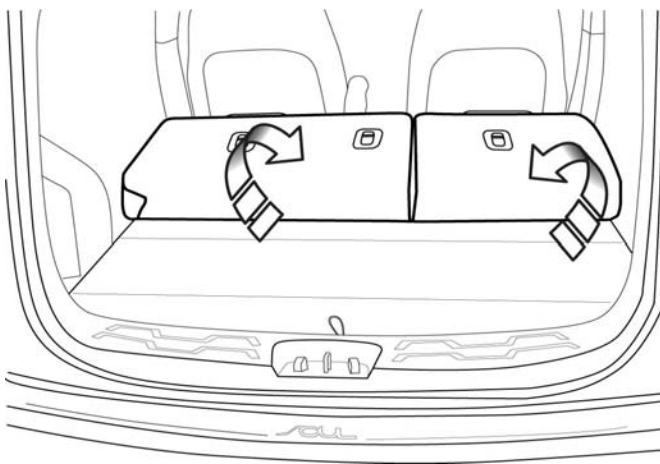
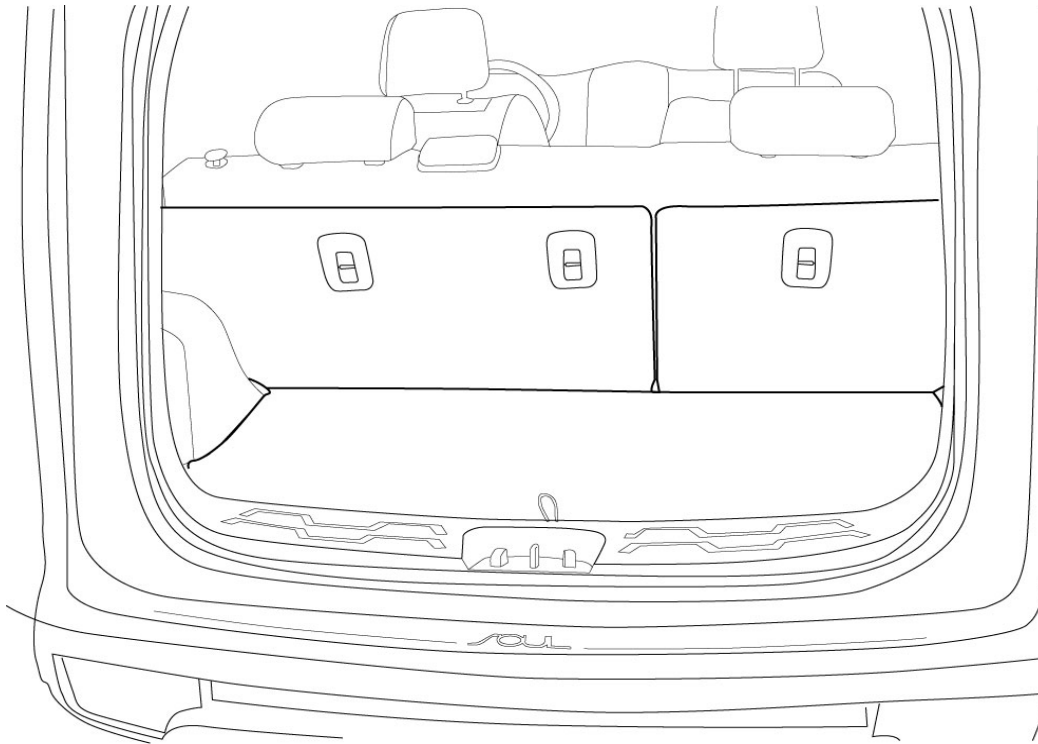

1

NOTE Position the 2nd row seat backs in the down position.

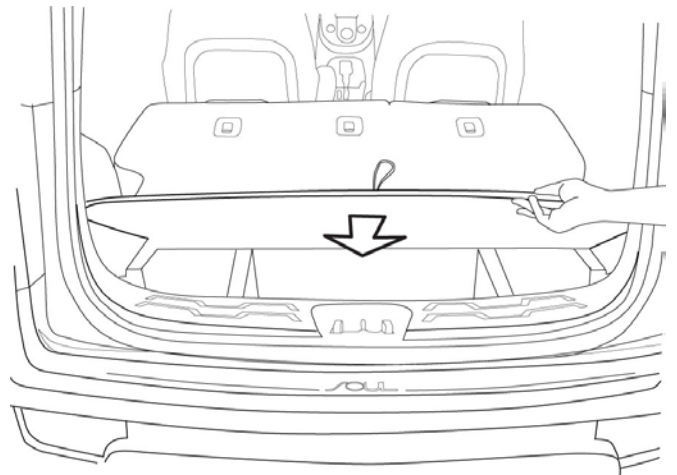

2

NOTE Remove the cargo storage cover from the vehicle and place it over a clean and protected floor or other surface.

KMA Genuine Approved Accessories (Accessory Installation)

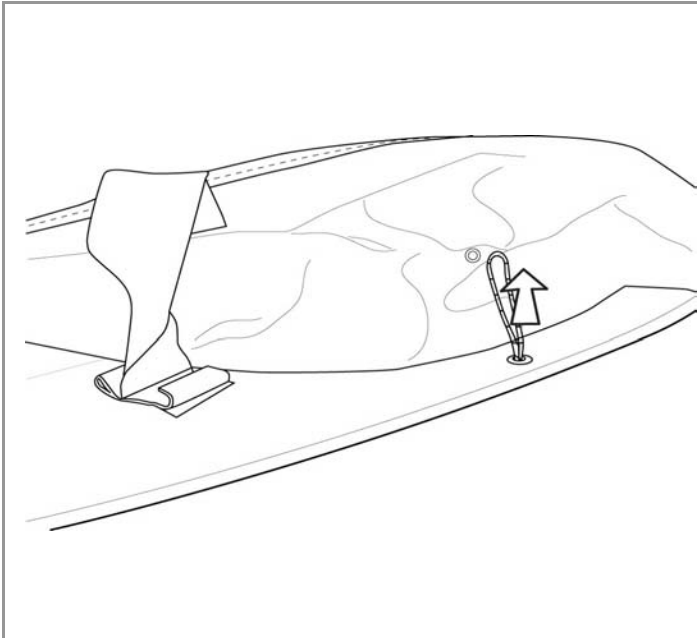

3

NOTE Thread the cargo storage cover string through the hole in the Cargo Liner.

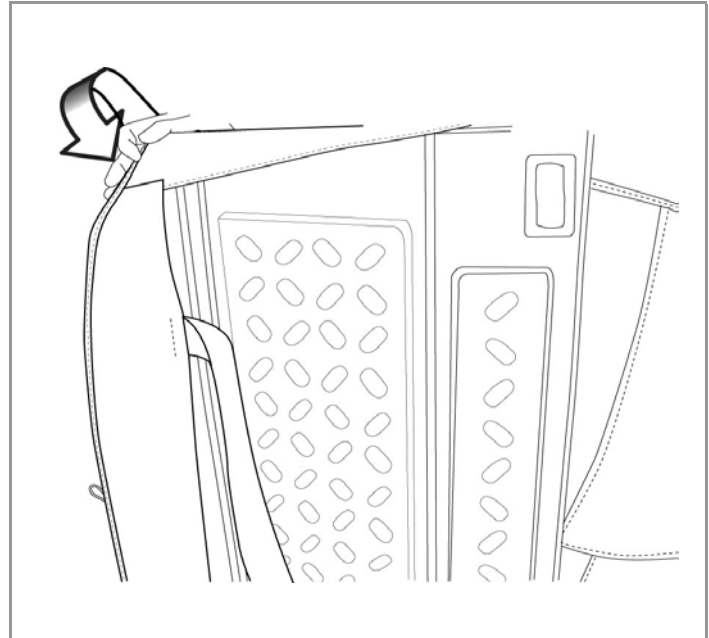

4

NOTE Attach the (2) corners of the Cargo Liner to the cargo cover as shown. Ensure the sides of the Cargo Liner overlap the cargo storage cover completely.

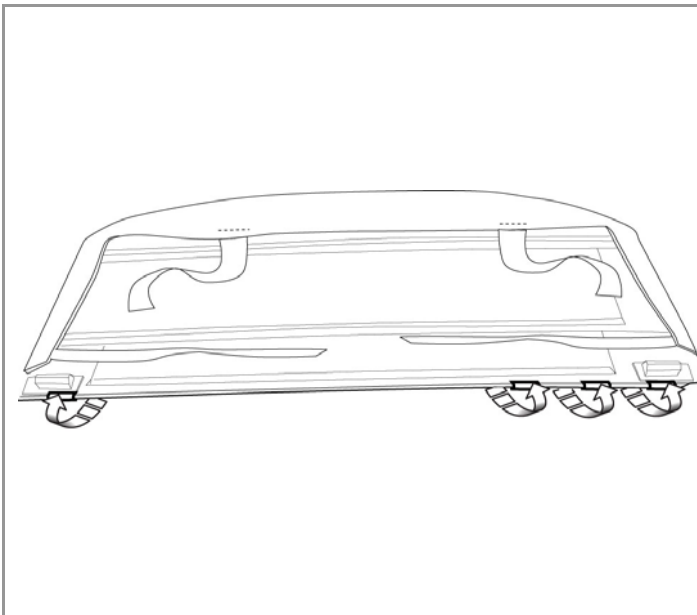

5

NOTE Attach the (4) middle clips underneath the soft Cargo Liner to the rear edge of the cargo storage cover.

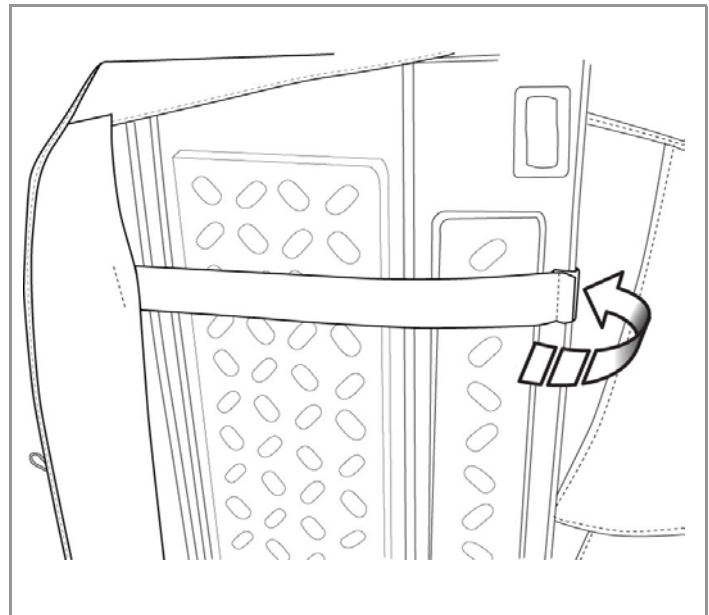

6

NOTE Attach the (2) bottom straps with clips to the rear edge of the cargo cover.

KMA Genuine Approved Accessories (Accessory Installation)

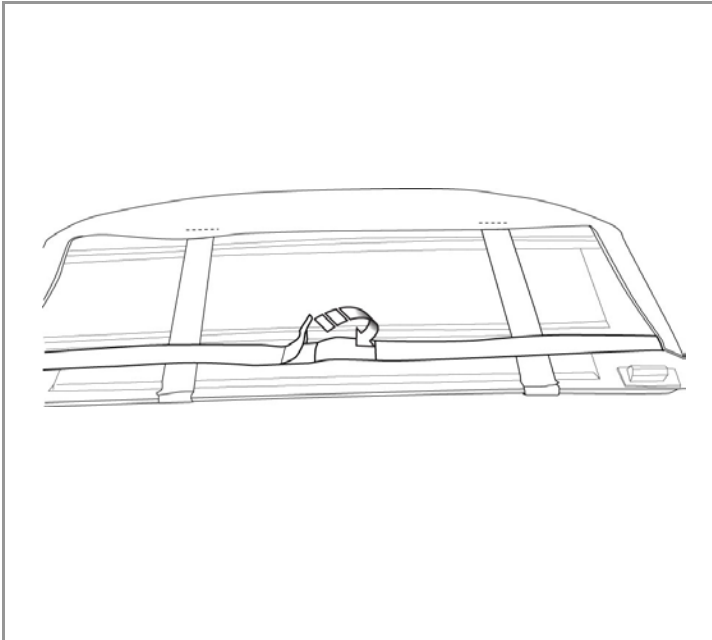

7

NOTE Attach the bottom strap with velcro together.



8

NOTE Gently lay the cargo storage cover back in place without reattaching the hinge rod. Be sure to leave the felt strips in place over the Velcro to prevent the Cargo Liner from sticking to the carpet during installation.

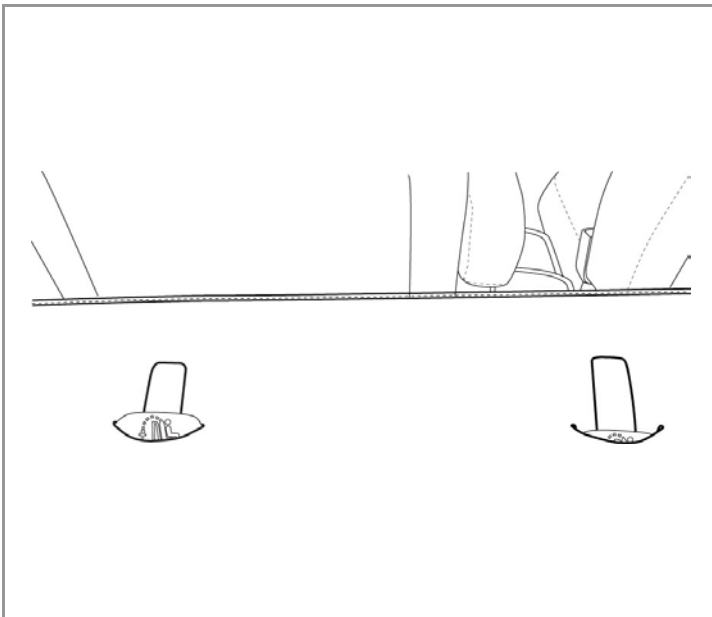

9

NOTE Begin with the driver side seat back cover. Align cut out slots on the back of the seat as shown. Repeat on the passenger side.

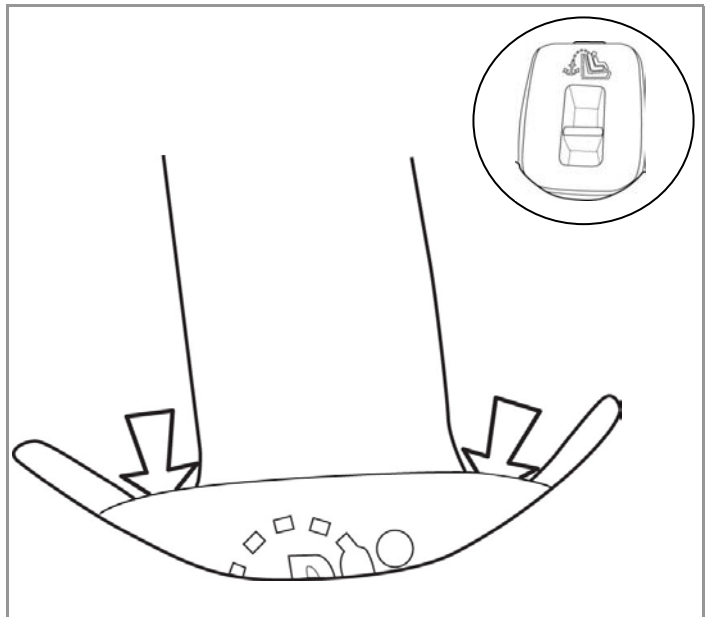

10

NOTE Slide the points of the cutouts behind the plastic child tether covers. Continue sliding the points down until fully engaging the plastic covers. Repeat on passenger side.

KMA Genuine Approved Accessories (Accessory Installation)

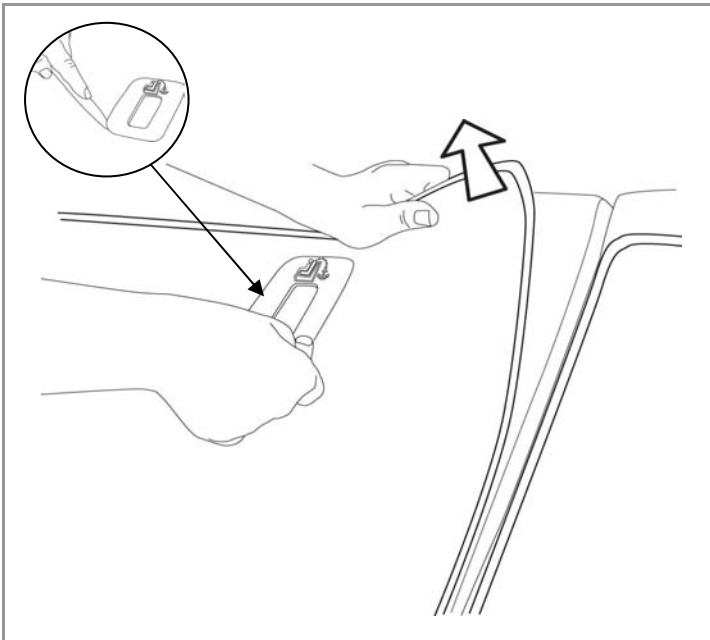

 Trim Tool 11

NOTE Lift the corner of the cargo liner to help insert it behind the bottom of the child tether cover. Repeat on the passenger side. It may be necessary to use the trim tool to complete this step.

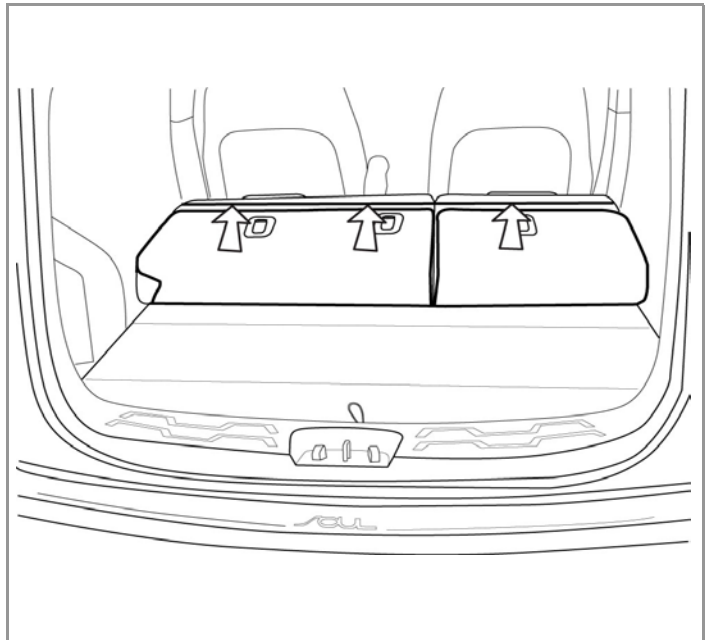

12

NOTE Slide the Cargo Liner forward to the seat back feature line. Make sure the part is straight on the seats.

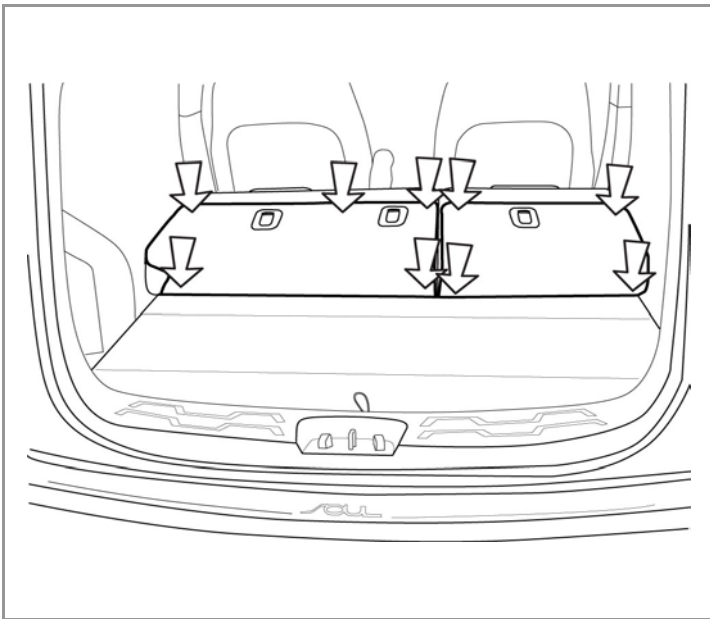

13



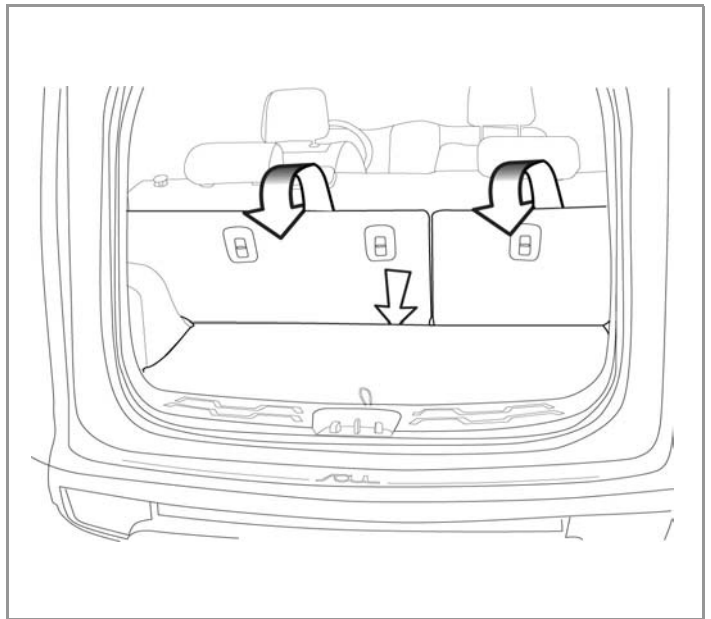

NOTE Remove the (9) felt strips and push on the attaching points. Make sure the Velcro is attached properly.





14

NOTE Reattach the cargo tray covering rod into the slots. Tuck any excess soft liner material down into the fold as you return the seats to the upright position.

KMA Genuine Approved Accessories (Visual Check)

| Items To Be Checked | Results of the Check |
|---|--|
|  <p>The Cargo Liner and the vehicle are both clean and dry.</p> | <p>The vehicle is clean and dry. The Cargo Liner is clean and dry on both sides. There is no moisture to cause possible molding.</p> |
|  <p>All clips, and Velcro are attached.</p> | <p>There are no loose attachment points.</p> |
|  <p>The Cargo Liner covers all the carpeted areas of the vehicle cargo area.</p> | <p>All areas of the vehicle cargo area that are meant to be protected by the Cargo Liner are covered.</p> |
|  <p>Check to ensure that the Cargo Liner is properly aligned.</p> | <p>The cargo cover area and tie-down hooks are all visible and the Cargo Liner does not impede their function.</p> |
|  <p>Hinge Rod is fully seated into the slots.</p> | <p>The cargo cover has been properly replaced, the hinge action is fully functional, and the cover closes completely.</p> |

KMA Genuine Approved Accessories (Care and Cleaning)

| Item in Question | Results of the Check | | | |
|---|---|------------------|---|-----------|
| <div style="display: flex; align-items: center;">  <div> <p>Clean the vehicle and the Cargo Liner.</p> </div> </div> | <table border="1" style="width: 100%; border-collapse: collapse;"> <tr> <td style="width: 30%; text-align: center;">Instruction Ref.</td> <td rowspan="2" style="padding: 5px;">The vehicle and the Cargo Liner should be cleaned when necessary. Use mild soap and water to remove dirt. Air dry completely. DO NOT USE A DRYER.</td> </tr> <tr> <td style="text-align: center;">All steps</td> </tr> </table> | Instruction Ref. | The vehicle and the Cargo Liner should be cleaned when necessary. Use mild soap and water to remove dirt. Air dry completely. DO NOT USE A DRYER. | All steps |
| Instruction Ref. | The vehicle and the Cargo Liner should be cleaned when necessary. Use mild soap and water to remove dirt. Air dry completely. DO NOT USE A DRYER. | | | |
| All steps | | | | |
| <div style="display: flex; align-items: center;">  <div> <p>Make sure the Cargo Liner is fitting properly.</p> </div> </div> | <table border="1" style="width: 100%; border-collapse: collapse;"> <tr> <td style="width: 30%; text-align: center;">Instruction Ref.</td> <td rowspan="2" style="padding: 5px;">If the Cargo Liner should impede the function of the cargo cover or tie-downs, adjust or remove the Cargo Liner. Periodically check the fit of the Cargo Liner.</td> </tr> <tr> <td style="text-align: center;">All steps</td> </tr> </table> | Instruction Ref. | If the Cargo Liner should impede the function of the cargo cover or tie-downs, adjust or remove the Cargo Liner. Periodically check the fit of the Cargo Liner. | All steps |
| Instruction Ref. | If the Cargo Liner should impede the function of the cargo cover or tie-downs, adjust or remove the Cargo Liner. Periodically check the fit of the Cargo Liner. | | | |
| All steps | | | | |